

Guide

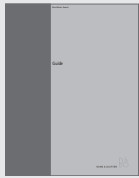

Should you loose or damage the BeoVision 5 CD-rom, the information can also be found on the Bang & Olufsen web-site; www.bang-olufsen.com or you can contact your retailer.

An explanation of symbols in the guides

The illustration below shows what a button, source or status display looks like in the instruction sequences used in the guides.

TV LIST Buttons on the Beo4 remote control



STORE Displays on the Beo4 remote control
P-IN-P

TV 12 Displays on the BeoVision 5
UPDATE

The User's guides

This **Guide** contains information about daily use, more advanced operations as well as basic setup and maintenance of your product.

The **CD-rom Reference book** contains information about connecting loudspeakers, adjusting loudspeaker setup, connecting external equipment, connecting an audio system and setting up and operating a BeoLink system. It also contains an overview of on-screen menus.

Both guides contain an index which can help you find the specific subject, you want to know more about.

We expect that your Bang & Olufsen retailer delivers the product to your home, installs it and makes all necessary connections as well as the initial setting-up. However, the information required to install and set up the product is included in the guides in case you need it at a later date if e.g. you move your products or expand your system.

The Reference book is a file in PDF-format on the enclosed CD-rom. To read this PDF-file, the Acrobat Reader program must be installed on your computer. If you do not have the program, it can be installed from the CD-rom. Then select the file with the language you want, and the Reference book opens.

Daily use, 4

Find out how to use BeoVision 5 and the Beo4 remote control, watch and select channels, adjust sound, look up Teletext information, and finally how to turn your BeoVision 5 into a Home theatre for watching movies.

Advanced operations, 12

All you need to know about using BeoVision 5 beyond daily use; advanced Teletext functions, timed play and timed standby, specific sound operations and presets, view two sources at the same time, operate connected video equipment with Beo4, and play and copy Camcorder recordings.

Setting up and socket overview, 22

Find out how to handle and place BeoVision 5, what can be connected to BeoVision 5, where to connect it, and how to register additional video equipment.

Tuning and preference settings, 30

Find out how to tune in, name or delete channels and decide the order in which they appear. This chapter also contains information about setting the time, date, picture and sound.

Maintenance, 40

Find out how to take care of your BeoVision 5 and how to use the built-in PIN-code system.











Index, 44

Find the specific subject you want to know more about.

Introducing BeoVision 5 and Beo4

Using the Beo4 remote control

Look through the basic principles of the Beo4 remote control and try them out. Each button on Beo4 is explained below.

Switch on the television	TV		TV	The Beo4 display shows the source you have selected, or extra functions available when you press the LIST button, e.g. FORMAT
Switch on e.g. a set-top box*	SAT		FORMAT	
Switch on a DVD player*	DVD		RADIO	Switch on radio, CD or audio tape recorder*
Switch on a video tape recorder*	V TAPE	TV LIGHT RADIO	CD	
Press twice to start recording here and now*	RECORD	SAT DVD CD	A TAPE	
Select channels or tracks*	0 – 9	V TAPE RECORD A TAPE	LIGHT	Adjust the room lights*
Switch on Teletext	TEXT	7 8 9	MENU	Call up the main menu for access to channel list, timer play and timer standby menus, as well as setup options
The coloured buttons give you access to different functions, depending on the source you have selected		4 5 6		Step between channels, chapters on a DVD or CD tracks*
Reveal additional functions in the Beo4 display**	LIST	1 2 3		
Press to stop playback of a videotape or disc; press to stop recording*	STOP	TEXT 0 MENU		Rewind or fast forward a videotape*
Adjust sound volume; press the middle to mute the sound			GO	Accept and store instructions or settings
		LIST  EXIT	EXIT	Exit all on-screen menus
		STOP  		Switch BeoVision 5 to standby

BANG & OLUFSEN

*To use these functions, the appropriate products and features must be available in your system.

**Refer to Beo4's own Guide for information about how to add extra functions to those shown in the Beo4 display window.

Displayed information and menus

Information about selected sources is displayed at the top of the screen. In addition, on-screen menus allow you to set or adjust additional functions.

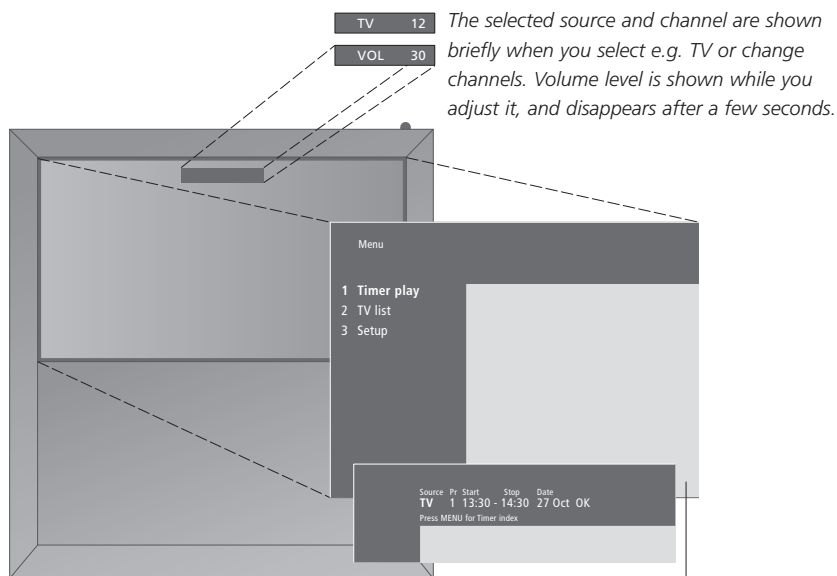

The selected source and channel are shown briefly when you select e.g. TV or change channels. Volume level is shown while you adjust it, and disappears after a few seconds.

On-screen menus will give you either a vertical list of options to choose from or a horizontal list of settings to fill in.

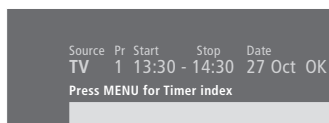

You can choose if you want the navigation cues in the menus to be shown. Factory setting of the function is On, but you can choose to deactivate it. Call up 'Menu' from the 'Setup' menu and choose 'On' to activate navigation cues or 'Off' to deactivate them.



To call up the menu system...

MENU Press **MENU** while the television is switched on

How to use option menus...

▲ ▼ Press to move through the option menu, or...

1 - 9 ...press the number keys on Beo4 to select a numbered option on a list

GO Press to enter your choice

How to use fill-in menus...

▲ ▼ Press ▲ or ▼ to view your choices for a single setting in a fill-in menu, or...
 ◀ ▶ Press to move from setting to setting

0 - 9 Press the number keys on Beo4 to enter settings

GO Press to enter your choice

In both option and fill-in menus, you can press **STOP** to go back to a previous menu, or **EXIT** to leave all menus.

Watch television

The functions shown on this page are often used on a daily basis:

- Choose a TV channel by its number;
- Switch to another channel or source;
- Call a channel list up on the screen;
- Adjust the sound volume;
- Turn BeoVision 5 so that it faces your viewing position. This requires that your BeoVision 5 is equipped with a motorised stand.

All of these functions can be performed with the Beo4 remote control.

Select a TV channel

To watch TV, press the appropriate button on Beo4. BeoVision 5 switches on the last channel you watched.

TV	Press to switch on the television.
TV 2	The last channel viewed appears on the screen
0 – 9	Press a channel number to go directly to that channel
▲	Press to step through channels one by one
▼	
DVD	Press another source button at any time to switch to that source, e.g. DVD
•	Press to switch BeoVision 5 to standby

See the channel list

All your TV channels appear on a list, which you can call up on the screen. The list contains channel numbers and names, and can contain 99 TV channels.

TV	Press to switch on the television
GO	Press and hold to call up the channel list on the screen
◀ ▶	Press to view the previous or following page of the channel list
0 – 9	To select a channel to watch, press the channel number on Beo4 or press the arrow keys until the cursor highlights the desired channel
▲	
▼	
GO	To switch on the chosen channel, press GO, or press EXIT to leave the menu
EXIT	

You can also call up the channel list by pressing MENU to call up the main menu, and then pressing 2 to select the TV list.

Adjust or mute the sound volume

You can adjust or mute television sound at any time while you are using a source.

∧ Press either end of the button to adjust the volume up or down
 ∨

Press the middle of the button to mute the sound

∧ Press either end of the button to bring the sound back
 ∨

Turn the television

If your BeoVision 5 is equipped with the motorised stand, you can turn the television to the left or right with the Beo4 remote control.

LIST Press repeatedly until STAND is shown in the Beo4 display
STAND

◀ ▶ Press to turn BeoVision 5 to the left or right, or...

0 ...press 0, 1 or 2 if you have
1 preset viewing positions for your
2 television

Refer to *Set positions for viewing and standby* on page 39 for further information about how to preset positions for TV viewing.

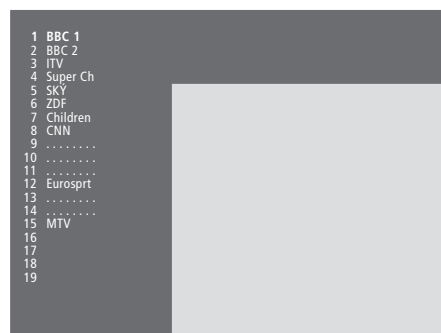

The TV channel list. Dotted lines indicate that a channel has been stored, but not named. An empty slot in the list indicates that no channel has been stored.

Home theatre viewing with BeoVision 5

You can extend your system into a fully equipped Home theatre system by connecting four Bang & Olufsen loudspeakers and a BeoLab 2 subwoofer*.

When you switch on BeoVision 5 or one of the sources connected to it, the speakers which you may have in a surround sound system can be cut in or out, depending on what kind of sound suits the source you are using.

BeoVision 5 may switch on a speaker combination automatically. This happens if e.g. a broadcasted programme or DVD contains information about the number of speakers to be switched on. You are still free to choose the speaker combination you prefer.

You can also adjust the picture dimensions to fill out the screen and complete the Home theatre experience.

Select speakers for movie sound

While you are watching a movie or programme, you can choose the speaker combination you wish to switch on, provided that the various sound modes are available in your system.

LIST	Press repeatedly until SPEAKER is shown in the Beo4 display
SPEAKER	
1 – 5	Press the number of the speaker option you want. The speakers selected will cut in automatically
▲	If you want to adjust the sound balance for the programme you are watching, press ▲ or ▼ to adjust the balance between the external front and rear speakers, and press ◀ or ▶ to adjust the balance between the left and right speakers
▼	
◀ ▶	
EXIT	Press EXIT to remove SPEAKER from the Beo4 display and to return to the source you were using

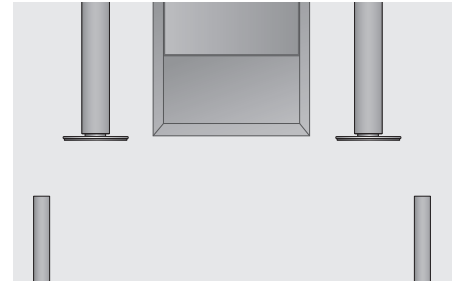

Speaker combinations

SPEAKER 1

Sound in the television speakers only. For programmes with dialogue, e.g. TV news.

SPEAKER 2

Stereo sound in the two external front speakers. The BeoLab 2 subwoofer is active. For music CDs.

SPEAKER 3

The television speakers, external front speakers and the BeoLab 2 subwoofer are active. For TV programmes in stereo.

SPEAKER 4

Enhanced stereo sound in the external front and rear speakers. The BeoLab 2 subwoofer is active. For music CDs or tapes.

SPEAKER 5

Surround sound from all speakers including the BeoLab 2 subwoofer. For programmes encoded in Surround Sound.

If you have connected only two external front speakers to the television, you will only be able to choose SPEAKER 1–3.

*NOTE! Refer to the BeoVision 5 CD-rom and the chapter *Loudspeaker setup – surround sound* for further information.

Make the picture fill out the screen

BeoVision 5 always ensures you the best possible picture. It automatically adapts the picture so that it fills out as much of the screen as possible. However, you can still choose a preferred format for Home theatre viewing.

LIST	Press repeatedly until FORMAT is shown in the Beo4 display
FORMAT	
GO	Press if you want BeoVision 5 to optimise the picture, otherwise...
1 – 3	...press the number of the desired picture format
▲	If you have chosen Format 1, press ▲ or ▼ to select variations of this format
▼	
▲	If you have chosen Format 2, press ▲ or ▼ to move the picture up and down
▼	
EXIT	Press to leave the FORMAT function

Picture formats to choose from

FORMAT 1

For standard TV pictures, as shown to the right. Two variations are available: Panoramic view (for the largest picture) and 4:3 (for standard picture format).

FORMAT 2

For letter-box pictures.

FORMAT 3

For genuine 16:9 wide-screen pictures. FORMAT 3 will usually be selected automatically. If this is not the case, you can select it yourself.



In format 1 BeoVision 5 automatically chooses the largest picture (panoramic view).

Teletext

If you select a channel and the broadcaster offers a Teletext service, BeoVision 5 gives you access to Teletext pages, any subpages linked to that page, and also four memory pages for storage of your most frequently viewed Teletext pages.

Stored memory pages are the first to appear when you call up Teletext on the screen, and Beo4 makes it easy to move quickly from page to page.

If you save the Teletext subtitles page as memory page number four, you can activate subtitles for that particular channel automatically.

Main Teletext functions

You can find information on Teletext pages in three steps: switch on the Teletext service, read the index page to find the desired page number, and call up the desired page.

TEXT	Press to call up the Teletext index page
0 – 9	Press the number of a Teletext page you want to see
▲ ▼	Press to move to the previous or following page
STOP	If the current page contains subpages, you can press STOP to pause subpage turning
0 – 9 ▲ ▼	To view a particular subpage, enter the four-digit number of the desired page, or press ▲ or ▼ to step to the page
STOP	Press STOP again to resume subpage turning
EXIT	Press to leave Teletext and return to the source you were using

Store frequently read pages

Store your favourite Teletext pages as memory pages so when you call up Teletext on the screen, these pages appear first.

TEXT	Press to call up Teletext
0 – 9 ▲ ▼	Press the number keys or ▲ ▼ on Beo4 to go to a page you refer to often
LIST STORE	Press repeatedly until STORE is shown in the Beo4 display
GO	Press to select the current page for storing
1 – 4	Enter the number of the memory page to be used
GO	Press to store the page as a memory page, or...
EXIT	...press to exit the STORE function and return to Teletext without storing

Please note that set-top box Teletext pages can be viewed, but not stored as memory pages!

NOTE! If your BeoVision 5 is linked via a BeoLink cable to another television, stored memory pages will not be shared among linked televisions. Memory pages must be stored manually on all linked televisions.

Daily use of memory pages

You may need to refer to your Teletext memory pages quickly, e.g. if you are leaving for work and wish to check traffic information on a Teletext service.

- TV** Press to turn on a TV channel which offers a Teletext service
- TEXT** Press to switch on Teletext. The page stored as memory page 1 appears automatically
- ◀ ▶** Press to view the other memory pages

To view stored memory pages from another channel's Teletext service, press EXIT on Beo4 to return to channel viewing, press ▲ ▼ or the channel number to change channels, and press TEXT to switch on Teletext.

Activate subtitles from Teletext

If a channel offers Teletext subtitles, you can activate subtitles for that channel. The Teletext subtitles page number can often be found in an index on Teletext page 100.

- 0 – 9** From Teletext, press the number keys or ▲ ▼ on Beo4 to locate the Teletext subtitles page. Subtitles appear on the screen
- EXIT** Press to cancel subtitles

To store subtitles permanently from the Teletext subtitles page...

- LIST** Press repeatedly until STORE is shown in the Beo4 display
- STORE**
- GO** Press to select the memory page
- 4** Press 4 to for memory page 4
- GO** Press to store subtitles
- To cancel stored subtitles, simply store another Teletext page as memory page number 4
- TV** Press to return to TV viewing

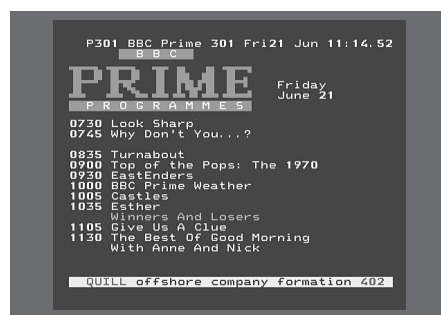

A typical Teletext page. The current page number, channel name, date and time appear at the top of the screen, as well as a three-digit number showing the progress of the page search function.

Advanced Teletext functions

If you select a channel that offers a Teletext service, BeoVision 5 gives you access to Teletext pages.

In addition BeoVision 5 supports three extra Teletext functions: text enlargement for easy reading, placement of a Teletext page over a TV picture, and display of hidden text e.g. the answer to a quiz or joke.

If your Teletext broadcaster offers a Fastext service, you can use the coloured buttons on Beo4 to step to one of four linked Teletext pages.

BeoVision 5 can also notify you when a desired page has been found or updated.

Teletext extra functions

While using teletext, you can enlarge the text, place the Teletext page over the TV picture or reveal hidden text.

To enlarge the screen text size...

LIST	Press repeatedly until LARGE is shown in the Beo4 display
LARGE	
GO	Press to activate – the upper half of the page is shown
GO	Press to view the lower half
GO	Press to restore the normal text size

To keep the TV picture in Teletext...

LIST	Press repeatedly until MIX is shown in the Beo4 display
MIX	
GO	Press to superimpose Teletext information on the TV picture
GO	Press to remove the TV picture

To reveal hidden text...

LIST	Press repeatedly until REVEAL is shown in the Beo4 display
REVEAL	
GO	Press to activate – if there is concealed text on that page, it will become visible
GO	Press to remove the revealed text

See updated Teletext pages

BeoVision 5 supports the page update function, provided by some Teletext broadcasters to announce that a Teletext page has been updated. This is useful e.g. if you want to see the latest news headlines while watching TV.

Call up the relevant Teletext page...

LIST	Press repeatedly until UPDATE is shown in the Beo4 display
UPDATE	
GO	Press to activate
FOUND	When the page is found, FOUND appears on the screen
UPDATE	When the page has been updated, UPDATE appears on the screen
GO	Press to see the located or updated page
EXIT	Press to leave Teletext

The function is cancelled when you change channels.

Recording from Teletext TV listings

If you have connected a BeoCord V 8000 to your BeoVision 5, you can preset a recording of a programme from a Teletext TV listings page.

- TEXT** Press to call up Teletext
- 0 – 9** Find the Teletext TV listings page, e.g. 301
- RECORD** Press to record – a cursor will highlight the first programme name or start time on the list
- ▲** Press **◀ ▶ ▲** or **▼** to move the cursor to the programme you wish to record
- GO** Press to select that programme – the cursor highlighting the programme will change to show the date, the channel number and channel name, followed by 'OK?'
- If this information is incorrect, press **◀ ▶** to move through the information and **▲** or **▼** to change the settings
- GO** Press to store your Timer recording – RECORD is shown

If you want to record additional programmes, you can continue to highlight listed programmes with the cursor.

Note about PDC/VPS and recording

When PDC (Program Delivery Control) or VPS (Video Programming System) is used, it means that the broadcaster attaches a coded signal to every programme they broadcast, ensuring that a recording will be recorded in full, even though the broadcasting of the programme in question was delayed, causing start and stop times to change.

If PDC or VPS signals follow the broadcast programmes you record, and the PDC/VPS facility is set to *On* in the video tape recorder's setup menu, then the title of the programme you want to record will be highlighted instead of the start time. There is no need to consider start and stop times, just accept the status line which appears instead of the programme title. If necessary, you can, of course, change the information displayed.



If PDC/VPS signals are not broadcast by the current channel, your recordings are preset by start and stop times, and will not adapt to broadcast delays or extensions. You will see the times at the top of the screen when you store a programme to be recorded.

Go directly to a page via Fastext

Some Teletext broadcasters offer immediate access facilities, called Fastext, that enable you to step directly to one of four linked Teletext pages. Fastext is supported by BeoVision 5.

- TEXT** Press to switch on Teletext

- ▲ ▼
0 – 9 Press ▲ or ▼ to find a Fastext page. Alternatively, enter the page number using the number keys

- ■
■ ■ Press one of the coloured buttons to gain access to the Fastext function. The titles of the four linked pages appear at the top of the screen

- ■
■ ■ Press the coloured button which corresponds to the linked page you wish to see

- TEXT** Press to leave Fastext and return to normal Teletext viewing, or...

- EXIT** ...press to leave Teletext completely



A Teletext page with the colour bar at the top right indicating that it is a Fastext page.



The titles of the four linked pages appear at the top of the activated Fastext page, each with their own colour.

The Picture-in-Picture function enables you to see two video sources on-screen simultaneously. While you are watching a programme or recording, you can prompt your BeoVision 5 to insert a small picture on the screen showing the source and channel number of your choice. For example, you can view a TV and a set-top box programme or a videotape playback and a TV programme at the same time, provided that these sources are available in your system.

Picture within a picture

When the Picture-in-Picture function is activated, operation with the Beo4 remote control is directed at the small picture, but the sound always follows the source shown on the whole television screen.

While watching e.g. TV...

- LIST** Press repeatedly until P-IN-P* is shown in the Beo4 display
- P-IN-P**
- SAT** Press e.g. SAT to select a source to view in the window
- 0** Press 0 to swap the large and small picture
- LIST** Press repeatedly until P-IN-P is shown in the Beo4 display – then press the coloured button corresponding to a corner of the screen to place the window on the screen
- P-IN-P**
- TV** Press a source button, such as TV, to cancel Picture-in-Picture and return to normal viewing

If P-IN-P is not available on the Beo4 display, you must add it to the Beo4 list of functions. Refer to Beo4's own Guide for further information.

**Note: To view a source registered in the 'Connections' menu as V.AUX, such as a set-top box, press LIST repeatedly until P-V.AUX is shown in the Beo4 display instead.*

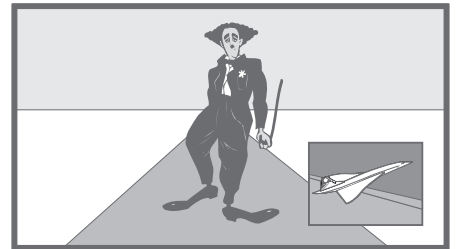
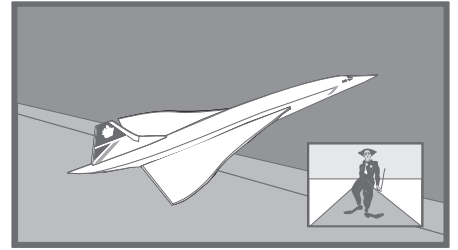

Use additional video equipment

Once your additional video equipment has been connected and registered in the *Connections* menu, as described on page 26, you can operate it with the Beo4 remote control.

If you have connected a set-top box, you can use the Beo4 remote control to gain access to the programmes and functions offered by your set-top box.

Refer to the BeoVision 5 CD-rom for further information on how to connect additional equipment.

Get access to additional video equipment

Some of the connected equipment is accessible via the Beo4 remote control.

V TAPE	Press to switch on a video tape recorder
DVD	Press to switch on a DVD or CDV player
LIST V.TAPE2	Press repeatedly until V.TAPE2 is shown in the Beo4 display
GO	Press to switch on a second video tape recorder
LIST V.AUX	Press repeatedly until V.AUX is shown in the Beo4 display
GO	Press to switch on a source registered as V.AUX, e.g. a set-top box

In order to display V.AUX or V.TAPE2 on Beo4, these options must be added to the Beo4 list of functions. Refer to Beo4's own Guide, for further information.

Set-top box operation

If you know which Beo4 button activates the function you want, you can call up the function without activating the Set-top Box Controller menu first.

GO 0 – 9	Press GO and the number key that activates the function you want
GO ▲ ▼	Press GO and then ▲ or ▼ to step up or down through programs directly
GO ◀ ▶	Press GO and then ◀ or ▶ while the set-top box menu is shown on the screen to step e.g. between menu pages or in program lists
GO	Press and hold GO to bring up the Program Guide or the Now-next banner on the screen depending on your set-top box

When set-top box is selected as source, press MENU twice to call up the TV's main menu.

Set-top Box Controller menu

Some of the buttons on your set-top box remote control are not immediately available on Beo4. To find out which Beo4 buttons activate specific services or functions in your set-top box, call up the Set-top Box Controller menu on the screen.

SAT Press to switch on the set-top box

MENU Press to call up the Set-top Box Controller menu

If your set-top box is registered as V.AUX...

LIST Press repeatedly until V.AUX is shown in the Beo4 display

GO Press to switch on the set-top box

MENU Press to call up the Set-top Box Controller menu

0 – 9 Press the number key that activates the function you want...

Or, press one of the coloured buttons to activate a function

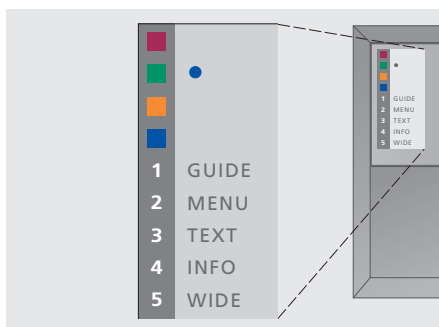

Example of a Set-top Box Controller menu – The Beo4 buttons are shown to the left on the menu and the set-top box buttons are shown to the right.

Change or check sound settings

See the active sound system

You can see the name of the active sound system for a source or programme on the screen. However, it is not possible to preset a sound system in this menu.

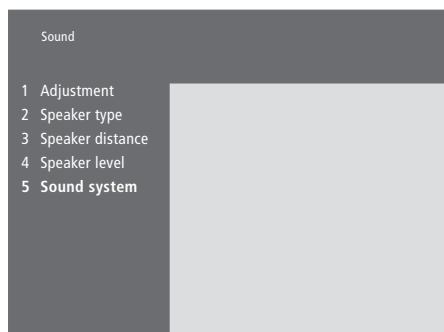

- > Press **MENU** to call up the main menu.
- > Press **3** to call up the *Setup* menu.
- > Press **2** to call up the *Sound* menu.
- > Press **5** to call up the *Sound system* menu. The current sound system is shown. Mono/Stereo appears if Dolby sound is not active.
- > Press **EXIT** or a source button, e.g. **TV**, to exit all menus.

Sound systems that can appear in the menu are: Dolby Digital, Dolby Surround Pro Logic, Dolby 3 Stereo, Dolby Digital + Dolby Surround Pro Logic and Mono/Stereo.

Change sound type or language

While watching television, the names of the various types of sound available will be shown on the screen as you proceed.

LIST Press repeatedly until **SOUND** is shown in the Beo4 display

SOUND

GO Press to see the current sound type on your screen

STEREO

GO Press repeatedly to switch to another sound type or language in a multi-language programme

GO

EXIT Press to exit the **SOUND** function

In order to display **SOUND in the Beo4 display, you must first add it to the Beo4 list of functions. Refer to the Beo4's own Guide for further information.*

NOTE! You can store your favourite sound type when tuning in your TV channels. Refer to 'Edit tuned TV channels' on page 32 for further information.

You can connect a Camcorder and watch your recordings or home movies on the BeoVision 5. If you have connected e.g. a BeoCord V 8000 video tape recorder to your BeoVision 5, you can copy Camcorder recordings onto a videotape.

Watch Camcorder on BeoVision 5

To watch your Camcorder recordings, connect the Camcorder and switch the BeoVision 5 on. When you start playback on your camera, the BeoVision 5 automatically registers the signal and you can see the pictures from the Camcorder on the screen.

To watch Camcorder recordings...

Connect your Camcorder and start playback on the Camcorder

TV Press to switch on BeoVision 5 – the Camcorder signal appears automatically

If the signal from the Camcorder gets switched off accidentally...

LIST Press until CAMCORD* is shown
CAMCORD in the Beo4 display and press **GO**
GO

**In order to display CAMCORD in the Beo4 display, you must first add it to the Beo4 list of functions. Refer to the Beo4's own Guide for further information.*

Copy from a Camcorder

When you connect your Camcorder to the direct access socket panel, you can copy Camcorder recordings onto a videotape. While the tape is being copied, you can watch a TV programme or switch BeoVision 5 to standby.

To copy a recording from a Camcorder...

Connect your Camcorder and start playback on the Camcorder

RECORD Press to prepare BeoCord V 8000 for recording

RECORD Press again to start recording

V TAPE Press V TAPE and then STOP to pause a recording
STOP

GO Press to resume a paused recording, or...

STOP ...press STOP again to stop a recording entirely

Make BeoVision 5 start or stop at a specific time

You can preset the timer to make BeoVision 5 start or stop automatically on a specific date and time, or at the same time and day every week.

You can enter as many as eight timer settings, and call up an on-screen list of the timer settings you have entered. From this list, you can edit or delete your timer settings.

If your BeoVision 5 is integrated with a Bang & Olufsen audio or video system with a Master Link cable, these systems can perform the Timer play or Timer standby functions*.

If you wish to enter timer settings, make sure that the built-in clock is set to the correct time. Refer to the chapter *Set the time and date* on page 38 for further information.

Timed play and timed standby

Use the Timer play function if e.g. there is a programme you do not want to miss, or if you want a morning wake-up call. Use Timer standby e.g. to make BeoVision 5 switch off automatically when you leave for work in the morning.



The system writes:

Jan...	January	Jul...	July
Feb...	February	Aug...	August
Mar...	March	Sep...	September
Apr...	April	Oct...	October
May...	May	Nov...	November
Jun...	June	Dec...	December
Mon...	Monday		
Tue...	Tuesday		
Wed...	Wednesday		
Thu...	Thursday		
Fri...	Friday		
Sat...	Saturday		
Sun...	Sunday		

To enter Timer play or Timer standby settings...

- > Press **MENU** on Beo4 to call up the main menu.
- > Press **GO** to call up the *Timer play* menu.
- > Press **GO** to call up the *Set Timer* menu.
- > Press **◀** or **▶** to move through menu items.
- > Press **▲** or **▼** to see your options for a menu item.
- > Press the number keys on Beo4 to fill in e.g. a channel number or start and stop times.
- > If you want to set Timer play for certain days of the week, press **▶▶** to highlight *Date* and then press **MENU** to change *Date* to *Days*. Select the specific weekday(s) on which you want your Timer executed. All the weekdays will be displayed – starting with M for Monday. Press **▶▶** to move through the days and press **▼** to remove any day you do not want. When the weekday(s) you want are displayed, press **GO**. OK is then highlighted.
- > When you have filled in the required information, press **GO** to store your timer settings, or **EXIT** to leave all on-screen menus without storing.

*NOTE! Make sure to switch on the Timer play function on the connected systems first. You can then program the timed settings for these systems on BeoVision 5. Refer to the User's guide for the audio system or television you have connected.

Switch on the Timer play function

You must activate the Timer play function in order for your timers to be executed.

To switch on the Timer play function...

- > Press **MENU** on Beo4 to call up the main menu.
- > Press **GO** to call up the *Timer play* menu.
- > Press **2** to call up the *Activate Timer* menu.
- > Press **▲** or **▼** to reveal *Yes*. To switch off the Timer play function, select *No* instead.
- > When you have filled in the required information, press **GO** to store your timer settings, or **EXIT** to leave all on-screen menus.

View, edit or delete a Timer

Call up an on-screen list of the timer settings you have entered. From this list, you can edit or delete your timer settings.

To view, edit or delete your Timer play settings...

- > In the *Timer play* menu, press **MENU** on Beo4 while *Source* (source) or *Pr* (program) is highlighted to call up a current Timer index of previously entered timer settings.
- > Press **▼** or **▲** to move through the list to a setting you wish to edit or delete.
- > To edit a setting, press **GO** and follow the procedure described in 'To enter Timer play or Timer standby settings...'
- > To be able to delete a setting, press **MENU**. The date will be replaced by *Clear?*
- > Press **GO** to delete the setting, or **EXIT** to keep it.

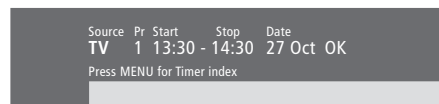

To see previously entered timer settings, press MENU and the Timer index appears.

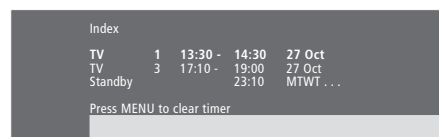

Here you can edit or delete your previously entered timer settings.

Setting up BeoVision 5

We recommend that you follow the procedure described below when you set up your BeoVision 5:

- Unpack the BeoVision 5 and place it as described and illustrated to the right under *Handling your BeoVision 5*;
- Consider the appropriate surroundings for your BeoVision 5. Guidelines are included to the right;
- Connect the cables, additional equipment, and speakers as described on the following pages and on the BeoVision 5 CD-rom.

For an overview of the connection panels, refer to the chapter *Socket panels* on page 28.

Handling your BeoVision 5

Due to the weight of BeoVision 5, any moving/lifting should always be done by two persons. BeoVision 5 is equipped with a special handle for lifting it out of the packing. After that the handle must be removed.

NOTE! BeoVision 5 is not designed to stand on its own, it must be supported until mounted on the chosen bracket or stand!

- Make sure that the BeoVision 5 is set up and connected in accordance with this Guide.
- The BeoVision 5 is developed for indoor use in dry, domestic environments only. Use BeoVision 5 within a temperature range of 10–40° C (50–105° F), and at an altitude of no more than 1500 metres (5000 ft.).
- Do not attempt to open the BeoVision 5. Leave such operations to qualified service personnel.

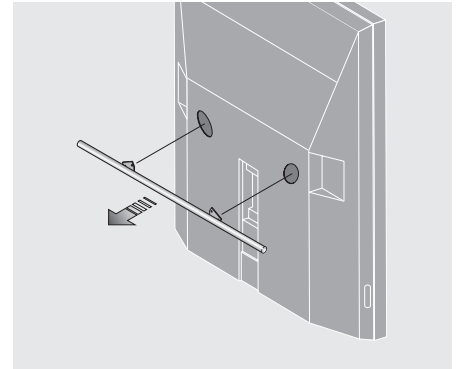

Before placing BeoVision 5 you must remove the handle.

Overview of socket and connection panels

The illustration to the right shows the placement of the various socket and connection panels on the BeoVision 5:

- 1 Card slot – for future use
- 2 Speaker and digital input socket panel
- 3 AV and aerial socket panel
- 4 Card slot – for future use
- 5 Direct access socket panel

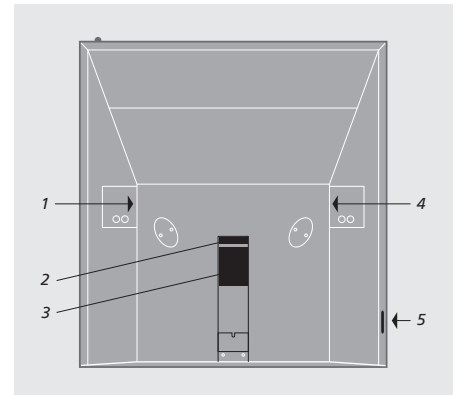

Placement options

The BeoVision 5 can be placed in several ways, some are illustrated to the right. Please contact a Bang & Olufsen retailer for further information.

Avoid placing your BeoVision 5 in direct sunlight or direct artificial light (e.g. a spotlight), as this may reduce the sensitivity of the remote control receiver. Do not place any items on top of the BeoVision 5.

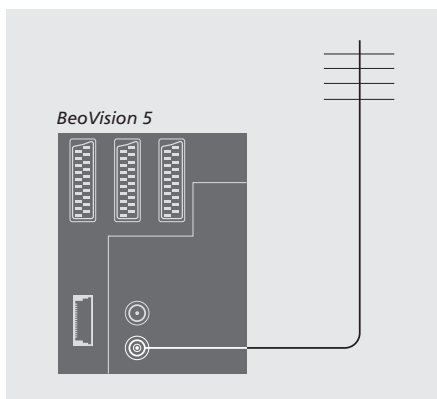
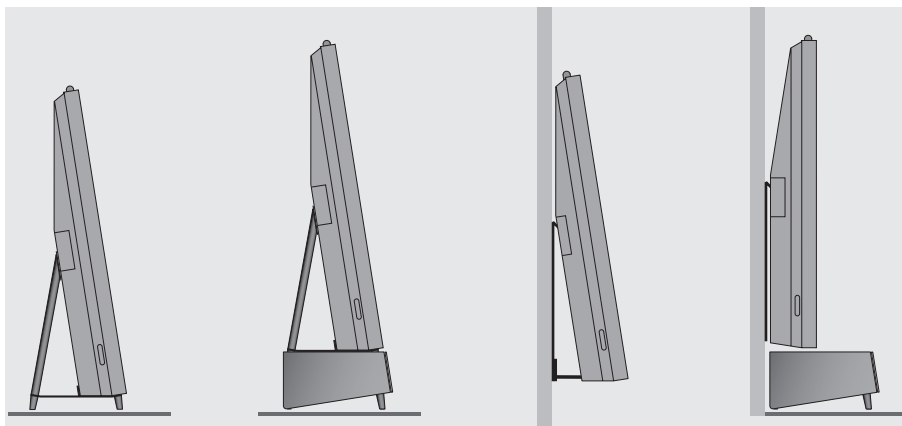

When connections are complete...

...you can connect BeoVision 5 to the mains. A tiny, red light appears on top of the screen. The system is in standby mode and ready to be used. If your BeoVision 5 is set up on its own, you can now begin tuning in channels, as explained in *Find available channels* on page 30.

Aerial and mains connection

Using an aerial cable, connect your external aerial (or a cable TV network) to the socket marked VHF/UHF on the BeoVision 5 rear socket panel.

If you are going to connect speakers, an audio system or any other equipment to BeoVision 5, do not switch on at the mains yet!

Warning!

The BeoVision 5 is equipped with a grounded mains lead and 3-pin plug. Due to the danger of electric shock it is advised not to remove the ground pin of the mains plug. This plug can only be connected to a grounded wall outlet. If a grounded wall outlet is not available, an electrician should be contacted.

Connect additional equipment

You can connect different types of audio and video equipment to BeoVision 5, such as a DVD player, set-top box or Camcorder.

Audio equipment is connected through the Master Link socket.

When connecting video equipment to your BeoVision 5, remember to use the AV socket on BeoVision 5 first, if it is vacant. For detailed information about connections, refer to the BeoVision 5 CD-rom.

Refer to the user's guide included with your additional equipment to make sure it is connected properly.

Remember to register all connected equipment. Refer to *Register additional video equipment* on page 26 for further information.

Audio Master

Using a BeoLink cable, connect the one multi-pin plug to the socket marked MASTER LINK on BeoVision 5, and the other multi-pin plug to the socket marked MASTER LINK on the audio system.

AV 2 Expander

The optional AV 2 Expander accessory enables you to connect more than one piece of extra equipment to the DECODER socket on BeoVision 5. You can connect a decoder, a DVD player, and other equipment to BeoVision 5 via the AV 2 Expander.

Use a 21-pin cable to connect one plug to the socket marked TV on the Expander box, and connect the other plug to the socket marked DECODER on BeoVision 5.

Set-top box

Use the 21-pin AV cable to connect the set-top box to your BeoVision 5. To enable remote control of your set-top box with the Beo4 remote control, you must also connect a low-power IR transmitter.

Decoder

To connect an AV decoder (a baseband decoder, e.g. Canal+, or a MAC decoder, etc.), connect the cable from the aerial to the BeoVision 5. Connect the AV decoder to the 21-pin socket marked DECODER on BeoVision 5.

To connect an RF decoder, connect the external aerial cable to the decoder input socket and then forward the cable to the BeoVision 5 aerial socket (marked VHF/UHF). Connect the RF decoder to the 21-pin socket marked DECODER on the BeoVision 5.

Video tape recorder

Use a 21-pin cable to connect a BeoCord V 8000 video tape recorder to the V.TAPE socket on BeoVision 5. Connect the cable from the aerial to the input socket on the video tape recorder. Forward the aerial cable to the aerial socket on BeoVision 5.

DVD player

Use a 21-pin cable to connect a DVD player, such as a Bang & Olufsen DVD 1, to BeoVision 5. Connect one end to the socket marked AV on your DVD player, and the other to the socket marked AV on BeoVision 5. Connect the socket marked DIGITAL OUTPUT on DVD 1 to the INPUT 1 socket on BeoVision 5. If the required cable is not enclosed, it is available from your Bang & Olufsen retailer.

Video game, Camcorder, etc.

We recommend that you use the direct access socket panel for equipment you connect on a temporary basis, e.g. video games or Camcorder. These sockets are placed on the left side of BeoVision 5. The use of these sockets is explained in the chapter *Direct access socket panel* on page 29.

Register additional video equipment

If you connect additional video sources or equipment to your BeoVision 5, then you must register the equipment in the *Connections* menu.

The settings you select in the Connections menu tell the BeoVision 5 what is connected.

For information about where and how to connect extra equipment, refer to the chapters *Connect additional equipment* on page 24 as well as *Socket panels* on page 28.

What is connected?

Registering the equipment connected to BeoVision 5 enables you to activate it with the Beo4 remote control.

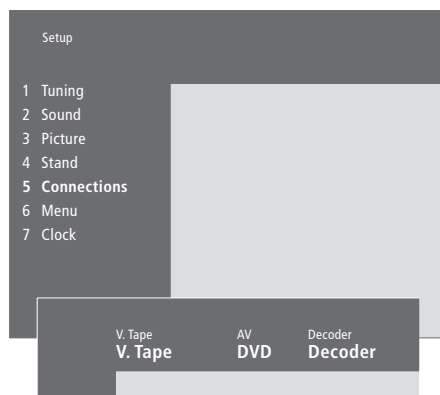

- > Press **MENU** to call up the main menu.
- > Press **3** to call up the *Setup* menu.
- > Press **4** to call up the *Connections* menu (5 if a motorised stand is installed).
- > Press **▶** to select a socket.
- > Press **▲** or **▼** to step through the list of available equipment types until you find what you have connected. Select *None* if nothing is connected.
- > When you have selected your equipment types, press **GO** to store your settings or press **EXIT** to leave all menus without storing.

Choose a set-top box

A list of set-top boxes to choose from appears when you register a set-top box in the *Connections* menu.

Equipment you can connect to each socket

V.Tape

V.Tape... for a Bang & Olufsen video tape recorder

DVD... for a DVD player

STB(SAT), STB(V.AUX)... for a set-top box

None... if nothing is connected

AV

DVD... for a DVD player

STB(SAT), STB(V.AUX)... for a set-top box.

Choose STB(SAT) if you have a secondary set-top box connected to the DECODER socket

V.AUX... for other equipment

Non B&O V.Tape2... for a non-Bang & Olufsen video tape recorder

V.Tape2... for a Bang & Olufsen video tape recorder

S-VHS V.TP2... for a Super-VHS video tape recorder

Decoder(2)... for a second decoder. Attach your primary decoder to the DECODER socket

Doorcam... for a door camera

None... if nothing is connected

Decoder

Decoder(1)... for a primary decoder or expander box

STB(SAT), STB(V.AUX)... for a set-top box.

Choose STB(V.AUX) if you have a primary set-top box connected to the AV socket

V.AUX... for other non-Bang & Olufsen equipment

Non B&O V.Tape2... for a non-Bang & Olufsen video tape recorder

None... if nothing is connected

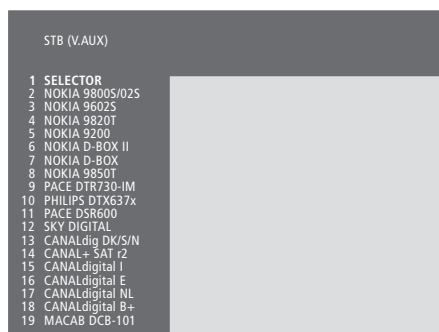

When the set-top box list appears...

> Press ▼ to move down the list.

> Press GO to select your STB type.

If your AV socket is in use, you can connect a second set-top box to the Camcorder socket. Refer to the chapter *Alternative set-top box connection* on the BeoVision 5 CD-rom for further information.

Socket panels

The rear socket panel on BeoVision 5 allows you to connect signal input cables as well as a variety of extra equipment, such as a DVD player or a Bang & Olufsen audio system.

The V.TAPE, AV and DECODER sockets are available for connection of extra equipment.

Any equipment you connect to these sockets must be registered in the BeoVision 5 *Connections* menu. Refer to the chapter *Register additional video equipment* on page 26 for further information.

Speaker and digital input socket panel

FRONT

The two sockets are used for connecting the external front speakers in a surround sound setup.

REAR

The two sockets are used for connecting the external rear speakers in a surround sound setup.

SUBWOOFER

Socket used for connecting a BeoLab 2 subwoofer in a surround sound setup.

INPUT 1

Digital input socket (S/P DIF) for connection of e.g. a DVD player. INPUT 1 is for digital input from equipment connected to the AV socket on BeoVision 5.

INPUT 2

Digital input socket (S/P DIF) for connection of e.g. a DVD player. INPUT 2 is for digital input from equipment connected to the V.TAPE socket on BeoVision 5.

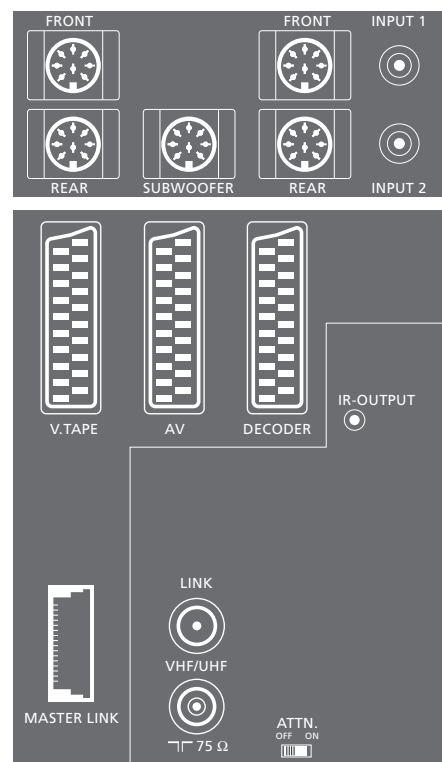

AV and aerial socket panel

V.TAPE

21-pin socket for the connection of a BeoCord V 8000 video tape recorder.

AV

21-pin socket for the AV connection of other equipment, e.g. a DVD player, a set-top box*, a second decoder (neither MAC nor baseband decoders may be connected here).

DECODER

21-pin socket for the connection of a secondary set-top box or a primary decoder. The socket provides the opportunity to connect either an AV decoder or an RF decoder.

The socket may be used for an AV 2 Expander instead, which gives the opportunity to connect a decoder, compact disc video player (CDV), and other non-Bang & Olufsen auxiliary video equipment at the same time.

MASTER LINK

Socket for connection of a compatible Bang & Olufsen audio system.

The socket is also used for BeoLink distribution of sound and picture throughout the house. In addition, the socket can be used for an external positioner box (used in a Satellite dish setup).

LINK

Aerial output socket for distribution of video signals to other rooms.

VHF/UHF

Aerial input socket for your external aerial or cable TV network.

ATTN. ON/OFF

Aerial signal attenuator. Options are:

OFF: Normal setting
ON: Signals damped

IR OUTPUT

For connection of a set-top box.

Direct access socket panel

PHONES

You can connect stereo headphones to the socket marked PHONES. The BeoVision 5 speakers can then be cut out by pressing the middle of the Beo4 volume button.

L – R – VIDEO

These sockets are for connection of a video camera:

L – R: For audio connection (left and right sound channel respectively).

VIDEO: For the video signal.

S-VHS

For the connection of S-VHS or Hi-8 Camcorder only.



*NOTE! You may connect the set-top box to either the DECODER, AV or V.TAPE socket. Which socket to choose depends on the other equipment you have connected.

You can make BeoVision 5 find your TV stations for you automatically.

During the *Add program* process, your previously tuned channels are left alone. This allows you to keep channel names, their order in the channel list, and any special settings you may have stored for those channels, such as decoder or broadcast system settings.

Find available channels

BeoVision 5 finds TV channels and stores them by number and name. Up to 99 different TV channels can be stored.

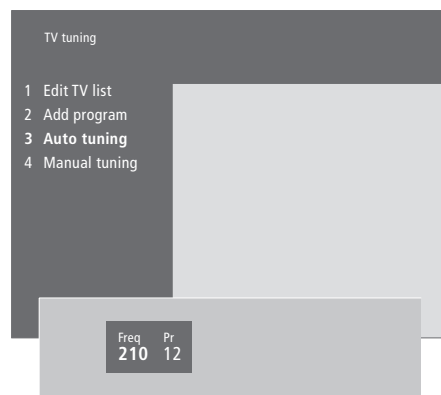

- > Press **MENU** to call up the main menu.
- > Press **3** to call up the *Setup* menu.
- > Press **GO** to call up the *Tuning* menu.
- > Press **GO** again to call up the *TV tuning* menu.
- > Press **3** to call up the *Auto tuning* menu. The *Freq* (frequency) and *Pr* (program) fields are shown.
- > Press **▲** to start automatic tuning. The content of the frequency and program fields will show tuning progress. Each time a channel is found, the process pauses shortly and then continues automatically.

When tuning is completed, you can rearrange, delete or rename channels from the channel list. This list also appears if you press STOP during auto tuning. Refer to the chapter 'Edit tuned TV channels' on pages 32–35 for information about editing the channel list.

Add new TV channels

The *Add program* process finds all new or previously deleted channels and adds them to the TV list.

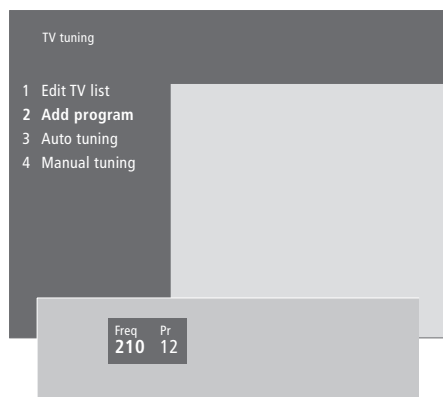

- > Press **MENU** to call up the main menu.
- > Press **3** to call up the *Setup* menu.
- > Press **GO** to call up the *Tuning* menu.
- > Press **GO** again to call up the *TV tuning* menu.
- > Press **2** to call up the *Add program* menu.
- > Press **▲** to begin adding new channels. The *Freq* (frequency) and *Pr* (program) fields will show tuning progress. BeoVision 5 searches through the entire frequency band and stops automatically when completed, then the channel list appears.
- > Press **STOP** to stop adding channels. You can then move, rename or delete channels from the list, as described on the following pages.
- > Press **EXIT** when your channels have been tuned in, named and placed in the order you choose.

Edit tuned TV channels

You can make adjustments to your tuned TV channels at any time.

You can tune in channels not stored during auto tuning by entering the channel frequency and channel number.

You can also enter settings before you tune in channels. These may include choosing a broadcast system for certain types of channels, or setting up a connected decoder to be switched on automatically whenever a coded channel is switched on.

In addition, you can edit your list of channels by renaming channels, moving them around in the list, or deleting them.

Finally, you can make adjustments to the individual channels by choosing a suitable sound type.

Adjust tuned TV channels

If you wish to program a channel for a particular sound type, then call up the *Manual tuning* menu.

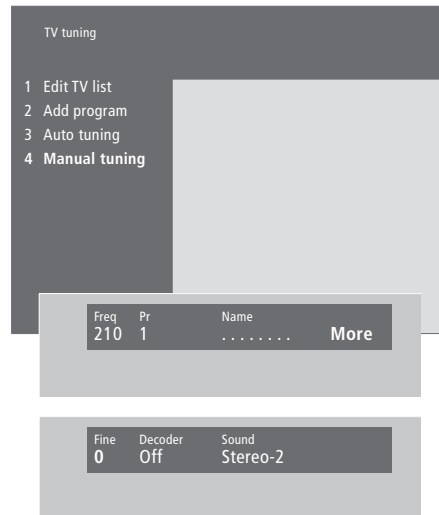

If the item 'System' appears on the menu, then make sure that the correct broadcast system is displayed before you begin tuning:

- B/G... for PAL/SECAM B/G
- I... for PAL I
- L... for SECAM L
- M... for NTSC
- D/K... for PAL/SECAM D/K

All options may not be available, as this depends on the television type.

- > Press **MENU** to call up the main menu.
- > Press **3** to call up the *Setup* menu.
- > Press **GO** to call up the *Tuning* menu.
- > Press **GO** again to call up the *TV tuning* menu.
- > Press **4** to call up the *Manual tuning* menu.
- > Press **◀** or **▶** to move between items on the menu and **▲** or **▼** to view your choices for each item. Pressing **▲** when the cursor is placed on *Freq* (frequency) will start automatic search for a channel. Numeric values can be entered using the number keys on Beo4. When entering names, press **▲** or **▼** to reveal the character you want. Then press **▶** to move to the next character position.
- > To view more options, press **▶** to move the cursor to *More* and press **GO**. If you set the item *Decoder* to *On*, *Dec1* or *Dec2*, you can return to the previous menu to start tuning in coded channels by pressing **GO**.
- > When a channel is tuned in, you can also select the sound system you want; press **▲** or **▼** to switch between the sound modes currently transmitted or fine tune the channel.
- > Press **GO** when you have entered your settings, or press **EXIT** to leave all menus without storing.

Move tuned channels

You can rearrange the order in which your channels appear when you switch channels, as well as in the on-screen channel list.

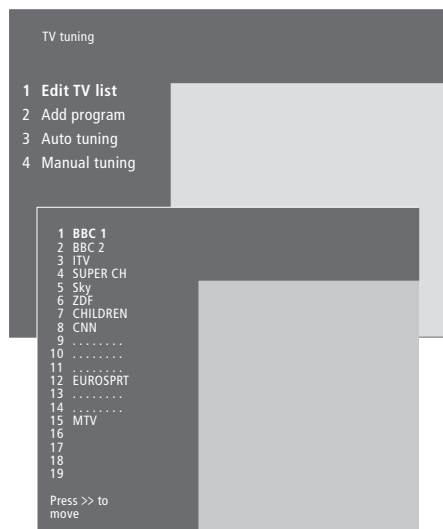

- > Press **MENU** to call up the main menu.
- > Press **3** to call up the *Setup* menu.
- > Press **GO** to call up the *Tuning* menu.
- > Press **GO** again to call up the *TV tuning* menu.
- > Press **GO** to call up the channel list.
- > Press **▼** or **▲** to move through your list of channels.
- > When you find a channel you wish to move, press **▶** to move it out of the list.
- > Press **▼** or **▲** to move the channel to its new location, or press the number of the new location.
- > Press **◀** to move the channel back into the list – if it changes places with another channel, this channel is moved out of the list and can be placed elsewhere.
- > When you have moved your channels, press **EXIT** to leave all menus.

You can select a channel for viewing while another channel is out of the list, but make sure you return the moved channel to the list before exiting the menu.

Name tuned channels

BeoVision 5 will name your tuned channels automatically during auto tuning, but you can rename your channels at any time.

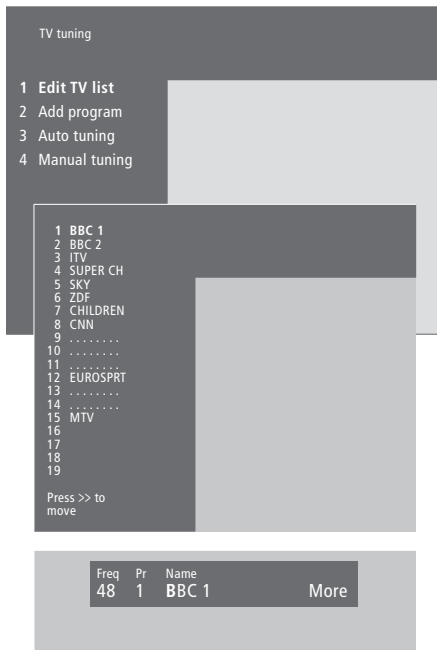

- > Press **MENU** to call up the main menu.
- > Press **3** to call up the *Setup* menu.
- > Press **GO** to call up the *Tuning* menu.
- > Press **GO** a second time to call up the *TV tuning* menu.
- > Press **GO** to call up the channel list.
- > Press **▼** or **▲** to move through your list of channels.
- > When you have found a channel you wish to name, press **GO**. The cursor will be located on the first character in the channel name. A name may contain up to eight characters, including the letters A-Z, numbers and full stop.
- > Press **▲** or **▼** to reveal the character you want. Then press **▶▶** to move on to the next character position.
- > Press **GO** to store a name and return to the list, or press **STOP** to return to the list without storing the name.
- > Press **EXIT** to leave all menus.

Delete tuned channels

You can remove any unwanted tuned channels from the channel list, thereby reducing the time you spend changing channels.

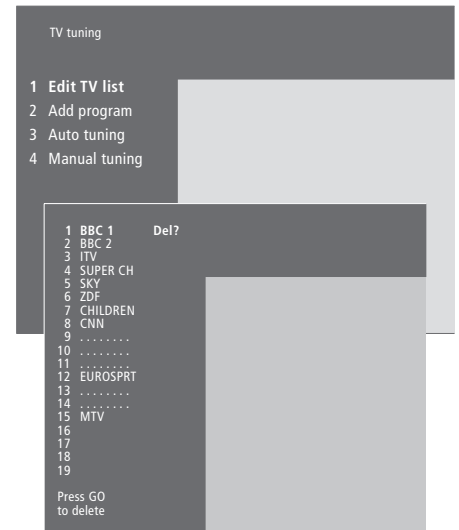

- > Press **MENU** to call up the main menu.
- > Press **3** to call up the *Setup* menu.
- > Press **GO** to call up the *Tuning* menu.
- > Press **GO** again to call up the *TV tuning* menu.
- > Press **GO** to call up the TV channel list.
- > Press **▼** or **▲** to move through your list of channels.
- > When you have found a channel you wish to delete, press **MENU**. *Del?* appears next to the channel name.
- > Press **GO** to delete the channel, or press **STOP** to return to the list without deleting the channel.
- > Press **EXIT** to leave all menus.

Adjust picture and sound settings

Picture and sound settings are preset at the factory to neutral values which suit most viewing and listening situations. However, if you wish, you can adjust these settings to your liking.

You can store your picture and sound settings temporarily – until BeoVision 5 is switched off – or you can store them permanently. Temporary settings are reset to neutral values when you switch off BeoVision 5.

Picture settings

Adjustment of the picture settings is done via the BeoVision 5 *Picture* menu. You can adjust picture brilliance, colour or contrast.



- > Press **MENU** to call up the main menu.
- > Press **3** to call up the *Setup* menu.
- > Press **3** to call up the *Picture* menu.
- > Press **◀** or **▶** to move between the items on the menu.
- > Press **▲** or **▼** to adjust the settings for each item.
- > Press **EXIT** to store your settings until you switch off BeoVision 5.
- > Press **GO** to store your settings permanently.

To change the picture format refer to the chapter 'Home theatre viewing with BeoVision 5' on page 8.

Sound settings

You can adjust sound volume with the Beo4 remote control at any time without calling up a menu, but you must call up the *Sound* menu to be able to adjust bass, treble or loudness.

You can also adjust a BeoLab 2 subwoofer, if it is part of your setup.

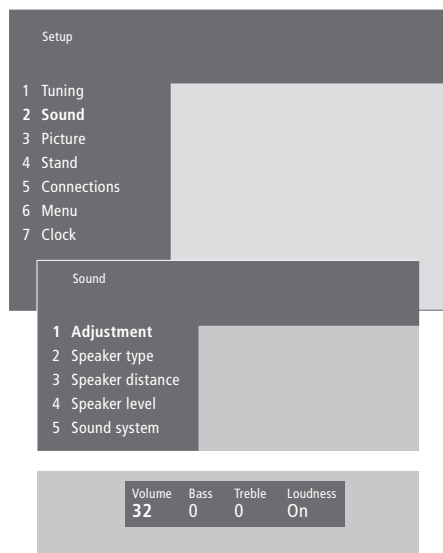

- > Press **MENU** to call up the main menu.
- > Press **3** to call up the *Setup* menu.
- > Press **2** to call up the *Sound* menu.
- > Press **GO** to call up the *Adjustment* menu.
- > Press **◀** or **▶** to move between menu items.
- > Press **▲** or **▼** to adjust the settings for each item.
- > Press **EXIT** to store your settings until you switch off BeoVision 5, or press **GO** to store your settings permanently.

The Sound menu lets you calibrate your surround sound speaker setup permanently. Refer to the BeoVision 5 CD-rom and the chapter 'Loudspeaker setup – surround sound' for further information.

Set the time and date

BeoVision 5 has a built-in 24-hour clock which must be set to the correct date and time.

When you preset BeoVision 5 to switch itself on or off at a particular time, or when you preset a Timer recording of a programme on a connected BeoCord V 8000 video tape recorder, the clock ensures that these features are switched on and off at the right times.

The simplest way to set the clock is to synchronise it with a tuned channel's Teletext service via BeoVision 5's *Clock* menu. It is only possible to synchronise the clock with the Teletext service offered by the TV channel you are currently watching. If a Teletext service is not available, you can set the clock manually.

Enter settings for the built-in clock

Before synchronising the clock with a tuned channel, make sure that the channel in question offers a Teletext service.

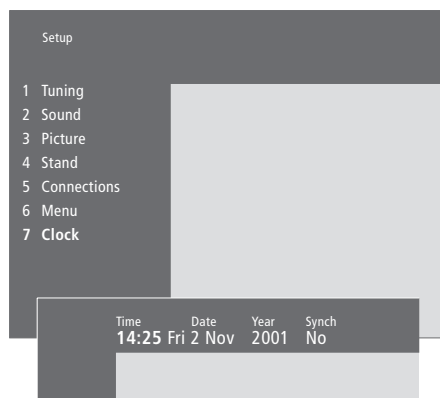

To set the time and date...

- > Press **MENU** to call up the main menu.
- > Press **3** to call up the *Setup* menu (**4** if *Sat* is available).
- > Press **6** to call up the *Clock* menu (**7** if a motorised stand is installed). *Time* is already highlighted. It is only necessary to enter the time manually if *SYNCH* is set to *No*.
- > Enter the time by pressing the number keys on your Beo4 remote control.
- > Press **◀** or **▶** to move through menu items.
- > Press **▲** or **▼** to see your options for a menu item. Select the current channel by pressing **▲** or **▼** until the channel name is shown.
- > Press **GO** to store your clock and calendar settings, or **EXIT** to leave all on-screen menus without storing.

Abbreviations for month and day of the week

<i>Jan...</i>	January	<i>Jul...</i>	July
<i>Feb...</i>	February	<i>Aug...</i>	August
<i>Mar...</i>	March	<i>Sep...</i>	September
<i>Apr...</i>	April	<i>Oct...</i>	October
<i>May...</i>	May	<i>Nov...</i>	November
<i>Jun...</i>	June	<i>Dec...</i>	December

<i>Mon...</i>	Monday
<i>Tue...</i>	Tuesday
<i>Wed...</i>	Wednesday
<i>Thu...</i>	Thursday
<i>Fri...</i>	Friday
<i>Sat...</i>	Saturday
<i>Sun...</i>	Sunday

If the clock is not updated in the transition between summer and winter time, simply select the channel with which you originally synchronised the clock.

If your BeoVision 5 is equipped with the motorised stand, you can turn it to the left or right using your Beo4 remote control.

You can program BeoVision 5 to turn automatically on its stand to face your favourite viewing position when you switch it on, and turn away to a standby angle when you switch it off. You can also turn BeoVision 5 to the desired positions manually.

Preset positions for BeoVision 5 to turn to

Choose one stand position for when you switch BeoVision 5 on and one for when you switch it off. You can also choose a secondary viewing position, if you have more than one favourite viewing angle.

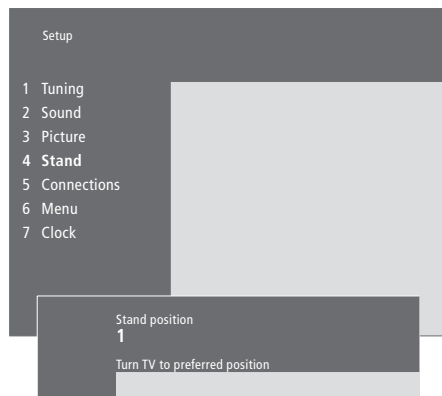

- > Press **MENU** to call up the main menu.
- > Press **3** to call up the *Setup* menu.
- > Press **4** to call up the *Stand* menu.
- > Press **▼** until the appropriate stand position is displayed.
- > Press **◀** or **▶** to rotate BeoVision 5 to the desired position.
- > Press **GO** to store the position.
- > Repeat the procedure for other stand positions.
- > Press **EXIT** to leave all on-screen menus.

Choose stand position 1 for primary viewing position, 2 for secondary viewing position, or 0 for standby position.

Maintenance

Normal maintenance, such as cleaning the BeoVision 5, is the responsibility of the user. To achieve the best result, follow the instructions to the right.

Any defective parts are covered by the guarantee during the warranty period. Please consult your Bang & Olufsen retailer to determine recommendations for normal maintenance.

Cleaning surfaces...

Wipe dust off the surfaces using a dry, soft cloth. Remove grease stains or persistent dirt with a lint-free, firmly wrung cloth, dipped in a solution of water containing only a few drops of mild detergent, such as washing-up liquid.

About the plasma screen...

Clean only with a dry cloth. Do not use liquid cleaners or aerosol cleaners.

Do not allow still pictures to be displayed on the screen for an extended period of time, as this can cause a permanent after-image to remain on the screen. Examples of still pictures are logos, video games, computer images and images displayed in 4:3 picture format.

NOTE! If the front screen glass should crack or chip, or if it should be damaged in any way, it must be replaced immediately, as it could otherwise cause injury. Please contact your Bang & Olufsen retailer.

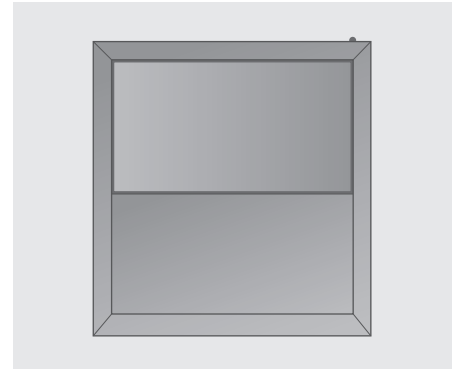

Never use alcohol or other solvents to clean any part of BeoVision 5!

The PIN-code system

You can protect your BeoVision 5 by entering a four-digit PIN (Personal Identification Number) code. Should your BeoVision 5 be disconnected from the mains for more than approximately 30 minutes, only those who know your PIN-code can gain access to your BeoVision 5.

To activate the PIN-code system, to change your code or to delete it altogether, you must call up the PIN-code setup menu.

If you should lose or forget your code, contact your Bang & Olufsen retailer for a Master code that disables your PIN-code and gives you access to your BeoVision 5.

Activate the PIN-code system



MENU	Press to call up the main menu
◀ ◀	Press ◀ twice, followed by STOP. The <i>Pincode</i> menu appears on the screen
STOP	To cancel code entry, press STOP and the input fields are cleared
0 – 9	Use the number keys on Beo4 to enter the four digits of your code
▶▶	When you have entered your code once, press ▶▶ to move the cursor to <i>Confirm pincode</i>
0 – 9	Re-enter the code a second time
GO	When you have entered the correct code twice, press GO. The BeoVision 5 on-screen display then shows the current source. If the two codes do not match, the input fields are cleared and you must enter the code again

Change or delete your PIN-code

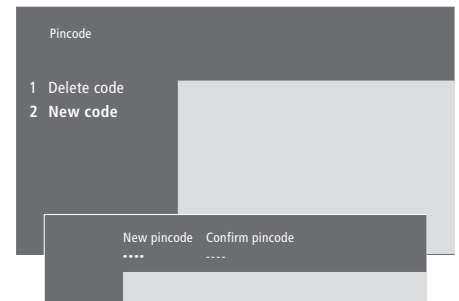

MENU	Press to call up the main menu
◀ ◀	Press ◀ twice, followed by STOP. The BeoVision 5 on-screen display prompts you for your PIN-code
STOP	To cancel code entry, press STOP and the input fields are cleared
0 – 9	Use the number keys on Beo4 to enter your PIN-code
▶▶	When you have entered your code once, press ▶▶ to move the cursor to <i>Confirm pincode</i> and re-enter the code
GO	Press GO to store the new code

NOTE! You can change your PIN-code up to five times in a three-hour period.

Use your PIN-code

Should your BeoVision 5 get disconnected from the mains for more than approximately 30 minutes, the BeoVision 5 on-screen display prompts you for the correct PIN-code when the television is turned on.

PIN _ _ _ _ _ Press the number keys on Beo4 to enter the code digits

0 – 9 If you enter an incorrect digit at any time, simply press STOP to reset the input fields

STOP

PIN _ _ _ _ _

PIN * * * * * BeoVision 5 restarts when the last digit is entered

TV 1

ERROR If an incorrect code is entered, **PIN** _ _ _ _ _ ERROR is shown in the on-screen display. Re-enter the code

Five incorrect entries will cause the BeoVision 5 to shut down for three hours, during which remote control access is not possible.

Did you forget your PIN-code?

Contact a Bang & Olufsen retailer to receive a five-digit Master Code.

When you have received a Master Code...

Connect your system to the mains

PIN _ _ _ _ _ When BeoVision 5 prompts you for your PIN-code, press and hold **◀◀** to call up the MASTERCODE display

PIN _ _ _ _ _

0 – 9 Entering this five-digit code via the number keys will deactivate your PIN-code and reactivate BeoVision 5. DELETED is shown in the BeoVision 5 on-screen display

DELETED

To start using your PIN-code again...

PIN _ _ _ _ _ Enter a new personal PIN-code and destroy the slip with your Master code

Index

Beo4 remote control

Get access to extra equipment via Beo4, 16
 Introducing Beo4, 4
 Using Beo4, 4–5

BeoLink

BeoVision 5 in a link room, *CD-rom p. 16*
 Link connections, *CD-rom p. 14*
 Link frequency, *CD-rom p. 15*
 Link room operation, *CD-rom p. 17*
 Link socket, 28, *CD-rom p. 12*
 Link systems throughout your home, *CD-rom p. 14*
 System modulator, *CD-rom p. 15*

Camcorder

Connect a Camcorder, 24 and 29
 Copy from a Camcorder to a videotape, 19
 Watch Camcorder recordings, 19

Clock

Enter settings for the built-in clock, 38
 What's on the 'Clock' menu, *CD-rom p. 24*

Connections

Additional video equipment, 24
 – DVD player, AV 2 Expander, Video tape recorder, Set-top box, Video Game, Camcorder etc.,
 Aerial and mains connection, 23
 Audio system, – connect to BeoVision 5, 24, *CD-rom p. 12*
 Connect BeoVision 5, 23
 Connect speakers, *CD-rom p. 4*
 Decoder – AV or RF decoder, 24, *CD-rom p. 9*
 Decoder – Two decoders, *CD-rom p. 9*
 Direct access socket panel, 29
 Headphones, 29
 Link room connections, *CD-rom p. 16*
 Link systems throughout your home, *CD-rom p. 14*
 Register additional video equipment, 26–27, *CD-rom p. 10*
 Set-top box – Alternative set-top box connection, *CD-rom p. 8*
 Set-top box – AV connection, *CD-rom p. 7*
 Set-top box – IR transmitter, *CD-rom p. 7*
 Socket panels, 28–29
 What's on the 'Connections' menu, *CD-rom p. 24*

Contact

Contact Bang & Olufsen, 46

Decoder

Connect AV or RF decoder, *CD-rom p. 9*
 Connect two decoders, *CD-rom p. 9*
 Socket panels, 28–29

Displays and menus

Display bar, 5
 Displayed information and menus, 5
 On-screen menus – index, *CD-rom p. 18*

Headphones

Connect to direct access socket panel, 29

Home theatre

Make the picture fill out the screen, 9
 Select speakers for movie sound, 8

Language

Change sound type or language, 18

Loudspeakers

Calibrate the sound level, *CD-rom p. 6*
 Connect speakers, *CD-rom p. 4*
 Place external speakers, *CD-rom p. 3*
 Select speakers for movie sound, 8
 Set speaker distance, *CD-rom p. 5*
 What's on the 'Speaker distance' menu, *CD-rom p. 23*
 What's on the 'Speaker level' menu, *CD-rom p. 23*
 What's on the 'Speaker type' menu, *CD-rom p. 23*

Maintenance

Day-to-day maintenance, 40
 Handling BeoVision 5, 22

Master Link

- Audio/video setup, *CD-rom pp. 12–13*
- Connect your audio system, *CD-rom p. 12*
- Option programming, *CD-rom p. 12*
- Use integrated audio/video system, *CD-rom p. 13*

Picture

- Change brilliance, colour or contrast, 36
- Make the picture fill out the screen, 9
- Picture-in-Picture, 15
- What's on the 'Picture' menu, *CD-rom p. 22*

PIN-code

- Activate the PIN-code system, 42
- Change or delete your PIN-code, 42
- Did you forget your PIN-code?, 43
- Use your PIN-code, 43

Placement

- Placing BeoVision 5, 23
- Placing external speakers, *CD-rom p. 3*

Position of TV

- Adjust viewing position, 7
- Preset stand positions, 39
- What's on the 'Stand' menu, *CD-rom p. 24*

Set-top box

- Alternative set-top box connection, *CD-rom p. 8*
- Set-top box – AV connection, *CD-rom p. 7*
- Set-top box – IR-transmitter, *CD-rom p. 7*

Socket panels

- AV and aerial socket panel, 28
- Connect additional equipment, 24, *CD-rom p. 10*
- Direct access socket panel, 29
- Overview of socket and connection panels, 22
- Speaker and digital input socket panel, 28

Sound

- Adjust or mute the sound volume, 7
- Calibrate the sound level, *CD-rom p. 6*
- Change sound type or language, 18
- Change volume, bass, treble or balance, 37
- Select speakers for movie sound, 8
- Video sound recording – AV setup, *CD-rom p. 13*
- What's on the 'sound Adjustment' menu, *CD-rom p. 22*

Subtitles

- Subtitles from Teletext, 11

Surround sound

- Loudspeaker setup – surround sound, *CD-rom pp. 3–6*
- Select speakers for movie sound, 8
- Socket panels, 28

Teletext

- Activate subtitles from Teletext, 11
- Go directly to a page via Fastext, 14
- Main Teletext functions, 10
- Memory pages – favourite Teletext pages, 11
- Preset a recording from Teletext TV listings, 13
- Store favourite Teletext pages – memory pages, 10
- Teletext – large, mix and reveal, 12
- Updated Teletext pages, 12

Timer

- Enter settings for the built-in clock, 38
- Make BeoVision 5 start or stop automatically, 20
- Switch on the Timer play function, 21
- To view, edit or delete a Timer, 21
- What's on the 'Activate Timer' menu, *CD-rom p. 19*
- What's on the 'Set Timer' menu, *CD-rom p. 19*

Tune

- Add new TV channels, 31
- Adjust tuned TV channels, 32
- Delete tuned channels, 35
- Find available TV channels, 30
- Move tuned channels, 33
- Name tuned channels, 34
- What's on the 'Add program' menu, *CD-rom p. 20*
- What's on the 'Auto tuning' menu, *CD-rom p. 20*
- What's on the 'first TV manual tuning' menu, *CD-rom p. 21*
- What's on the 'second TV manual tuning' menu, *CD-rom p. 21*

TV channels

- Add new TV channels, 31
- Adjust tuned TV channels, 32
- Delete tuned channels, 35
- Find available channels, 30
- Move tuned channels, 33
- Name tuned channels, 34
- See the channel list, 6
- Select a TV channel, 6
- What's on the 'Edit TV list' menu, *CD-rom p. 20*

For your information...

Your needs as a user are given careful consideration during the design and development process of a Bang & Olufsen product and we strive to make our products easy and comfortable to operate. Therefore, we hope that you will take the time to tell us about your experiences with your Bang & Olufsen product. Anything which you consider important – positive or negative – may help us in our efforts to refine our products.
Thank you!

Write to: Bang & Olufsen a/s
Customer Service
Dept. 7210
Peter Bangsvej 15
DK-7600 Struer

or fax: Bang & Olufsen
Customer Service
+45 97 85 39 11 (fax)

or Email: beoinfo1@bang-olufsen.dk

Visit our Web-site on...
www.bang-olufsen.com



This product fulfils the conditions stated in the
EEU directives 89/336 and 73/23.

Manufactured under license from Dolby
Laboratories. Confidential unpublished works.
Copyright 1992-1997. All rights reserved.

DOLBY, DOLBY DIGITAL, PRO LOGIC and the
double-D symbol are trademarks of Dolby
Laboratories Licensing Corporation.